



**Installation Guidelines for
Vanguard CANPEX™
Plumbing Systems
with Crimp Insert Fittings**

SDR-9 PEX
Cross-linked Polyethylene

For Traditional or Manifold
Plumbing Systems

Revised April 27, 2011

Important Notice

This installation guide is intended for traditional (branch and main) plumbing systems and hybrid plumbing systems using termination manifolds.

NOTE: References to CANPEX™ tubing made throughout this publication include the entire line of Vanguard cross-linked polyethylene products.

In the event of conflict or inconsistency between these installation guidelines and local building or plumbing codes, local codes should take precedence.

NOTE: Failure to follow the installation instructions will void the Vanguard CANPEX and Insert Fittings System warranty. Nothing in this publication is intended to create any warranty beyond Vanguard's applicable warranty. For additional information, contact Vanguard at 1-888-747-3739.

Compatibility of System Components

Vanguard CANPEX tubing and crimp fittings are manufactured to nationally recognized ASTM (American Standards for Testing and Materials) standard specification. CANPEX PEX tubing is produced to ASTM F876/ F877 and is tested and listed by recognized agencies (such as NSF International) to the requirements of these standards. CANPEX PEX tubing has a design pressure rating of 100 psi @ 180°F, and 160 psi @ 73°F. These are maximum-use ratings. CANPEX PEX tubing and resin used in the manufacture of CANPEX tubing have been tested, and listed by NSF to meet the requirements of ANSI/NSF 14/61, and have a chlorine and UV rating of PEX 5306 (our tubing also meets the voluntary protocol P171 CL-R/CL-TD chlorine resistance rating and extended 6-month UV exposure ratings).

Brass crimp metallic fittings are manufactured to ASTM F1807 and crimp PolyAlloy fitting are manufactured to ASTM F2159. Both fitting types meet the performance and health effects requirements of ANSI/NSF 14/61.

There are competing PEX tubing and fittings suppliers that also manufacture to these same standards. As such, the use of Vanguard CANPEX tubing or crimp fitting system components, or both, with a competitor's PEX tubing made to ASTM F876 or F877, or fitting system components made to ASTM F1807 or F2159, will not affect Vanguard's product warranty. However, Vanguard warrants only those components that we manufacture or distribute.

Always use the correct fittings and crimp rings in their appropriate fittings systems. Fittings designed for Polybutylene systems must not be used in PEX systems.

Table of Contents

Manual content and use	4
Know your materials	5
User proper tools	6
Making crimp connections	7–8
Daily tool calibration check	9
Adjusting the “HAR” tools	10
Adjusting the “HCM” tools	11
System sizing & calculations	12–13
Installing CANPEX™ tubing	14-19
Transition to fixtures	20–21
Proper use of materials	22
System testing	23–24
System disinfection	25
CANPEX™ warranty	26

Installation guidelines for Vanguard CANPEX plumbing system with crimp insert fittings is published by Vanguard Pipe & Fittings Ltd. 8125 North Fraser Way, Burnaby, BC V5J 5M8 Canada. Copyright 2011 Vanguard Pipe & Fittings Ltd. and CANPEX are registered trademarks of Vanguard Pipe & Fittings Ltd.

Manual Content and Use

This book of installation guidelines contains information on the installation of CANPEX SDR9 cross-linked polyethylene (PEX) tubing, crimp insert fittings and copper crimp rings in hot and cold potable water distribution systems.

The installer shall be thoroughly familiar with the contents of this manual before proceeding. Consult local codes for additional installation requirements and/or Vanguard Pipe & Fittings Ltd. for additional, specific product information.

Important: CANPEX systems are intended for hot and cold potable water distribution systems, radiant heating systems and other hot and cold water applications. Installation of a CANPEX plumbing system for the purposes other than those recommended by Vanguard is a misapplication of the product and voids product warranties. Contact Vanguard Pipe & Fittings Ltd. before applying this system for any use other than those recommended.

Uses of CANPEX™ Piping

CANPEX SDR9 PEX tubing and components must be installed in accordance with good plumbing practices, applicable code requirements, and current installation instructions. It is the responsibility of the contractor or installer to appropriately design the system, determine that the selection of CANPEX tubing and the joining system components are the proper ones for the intended application, and that he and/or his employees observe the installation practices recommended by Vanguard. If there is any doubt whether water conditions or other conditions likely to be encountered in the intended application may be harmful to PEX components, call a Vanguard representative at 1-888-747-3739.



CAUTION!

Tubing that exhibits damage such as cuts, scratches, gouges, kinks, fading, or discoloration, evidence of grease, tar or any chemical exposure shall not be used. CANPEX tubing must be stored away from direct and indirect sunlight.

A damp rag is all that should be required for cleaning the tubing. If any materials (other than those allowed in this publication) has adhered itself to the tubing and cannot be removed in this manner, do not use that section of tubing. NEVER use thinners, pipe sealants, solvent cements, fluxes, lubricants, other oxidizing agents or petroleum based materials to seal or clean CANPEX tubing.

Fittings And Crimp Rings

Brass, copper and PolyAlloy insert fittings are installed into the ends of 3/8" - 1" CANPEX tubing. A permanent, sealed connection is made by properly crimping a ring around the tubing, pressing the PEX into the spaces between the ribs of the inserted fitting.

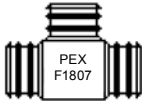

Vanguard blackened copper rings are marked with ASTM F1807 and are annealed for ease of crimping. The rings must be located over the ribs of the inserted fitting and crimped into place with a properly calibrated crimping tool.



Do not use:

- Copper-colored rings designed for polybutylene systems
- Fittings which have defects such as cuts, gouges, or abrasions
- Hose clamps or solvent cements
- Metallic fittings that are not marked PEX and F1807
- Fittings that are not marked as compliant with ANSI/NSF 14/61 such as NSF-pw
- Lubricants of any kind on the tubing or fittings

Pex Tubing

- The tubing shall meet the dimensional and performance requirements of ASTM F876/F877
- The tubing shall be third-party certified for use in potable water systems; i.e. NSF-pw (NSF International), Standards 14/61 and PEX 5306, CL-R/CL-TD, Chlorine Resistance of Plastic Piping Materials.

Do not install tubing that has defects such as:

- Gouges, cuts, deep scratches
- Evidence of grease, tar or any chemical exposure
- Kinks
- Fading or discoloration

LOOK FOR THE PROPER MARKINGS

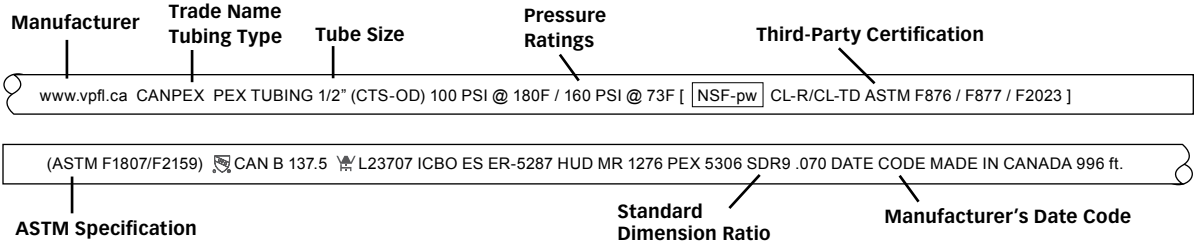

PROPER USE OF MATERIALS

Do not install where exposed to direct or indirect sunlight for more than 60 days. PEX tubing shall be stored under cover, shielded from direct and indirect sunlight when the material is stored for any length of time. Short exposure times, not exceeding a total accumulated time of 60 days maximum, are permissible.

Use Proper Tools

Hand Crimping Tools

Use only FULL CIRCLE crimp tools designed for CANPEX crimp insert fitting systems. Tools must produce crimps in accordance with dimensional requirements of ASTM F1807 (shown on page 8). **DO NOT** use tools which produce an "eared" crimp. See pages 9 through 11 for tool calibration and adjustment procedures. Vanguard recommends checking at least the first and last crimp of the day with a GO/NO GO gauge.

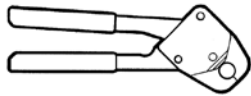

Vanguard Model HCM-2 – 3/8"
HCM-3 – 1/2"
HCM-4 – 3/4"
HCM-5 – 1"

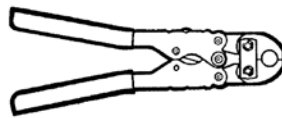

Vanguard Model HAR-2 – 3/8"
HAR-3 – 1/2"
HAR-4 – 3/4"
HAR-5 – 1"

Tubing Cutters

The Vanguard TUBING CUTTER will cut PEX cleanly and evenly.

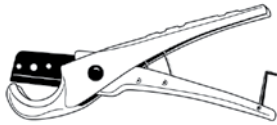

Vanguard Kwik Cutter
Model HAK67

Go/No Go Crimp Measuring Gauge

Vanguard GO/NO GO Crimp Ring Measuring Gauge

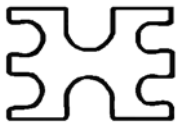

Vanguard GO/NO GO Crimp Ring Measuring Gauge
Model HAC34 (3/8" - 3/4")
Model HAC5 (1")

Care For Your Tools

- Check tool calibration at least twice daily. Vanguard recommends at least the first and last crimp of the day (See pages 9 - 11).
- Examine tools frequently for loose or missing parts, wear and damage. **DO NOT** use tools that are in need of repair.
- A tool with worn parts may not calibrate. Return worn tools to the manufacturer for repair or replacement.
- Lubricate all tool pivot points regularly with light oil. Wipe off excess oil before using tools.
- **DO NOT** use crimp tools for other purposes.
- **DO NOT** throw or drop tools.
- **DO NOT** use a crimp gauge which is bent or damaged.
- Keep the tubing cutters sharp. Replace blade as needed.

Making Crimp Connection

Making Crimp Connections

Follow these instructions carefully to ensure proper crimp connections.

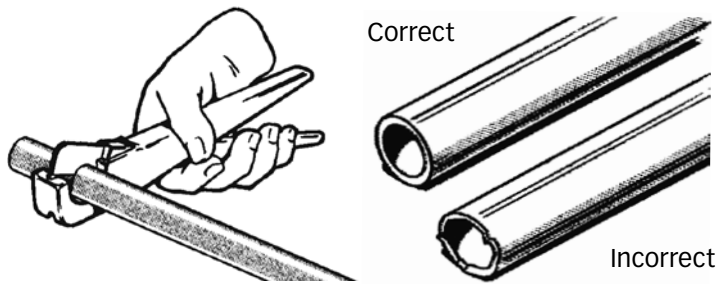

1. The tubing should be cut squarely and evenly without burrs. Uneven, jagged or irregular cuts will produce unsatisfactory connections.

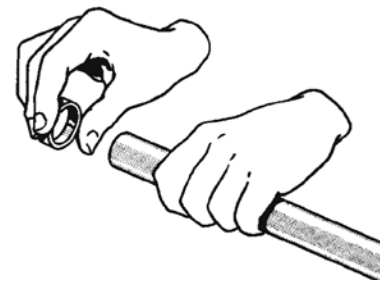

2. Slide the correct size blackened copper crimp ring over the tubing end.

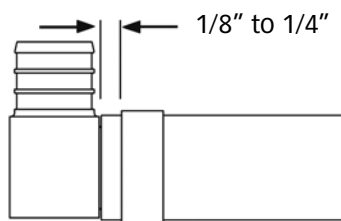

3. Insert the fitting into the pipe to the shoulder or tube stop. Position the ring 1/8" to 1/4" from the end of the tubing.

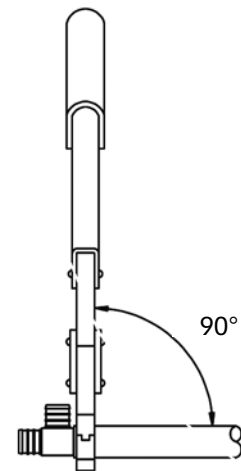

4. The ring must be attached straight. Center the crimping tool jaws exactly over the ring. Keep the tool at 90° and close the handles completely. **DO NOT CRIMP TWICE.**

Making Crimp Connections (Continued on page 8).

Making Crimp Connection

Making Crimp Connections

(Continued from page 7).



5. When checking crimps with a GO/NO GO gauge, push the gauge **STRAIGHT DOWN** over the crimped ring. **NEVER** slide the gauge in from the side. Do not attempt to gauge the crimp at the jaw overlap area.

The overlap area is indicated by a slight removal of the blackening treatment.

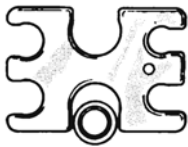

6. You have a **good crimp** if the GO gauge fits the ring in at least 4 places and the NO GO does not.

You have a **bad crimp** if the GO gauge does not fit the ring or the NO GO gauge does fit.

Bad crimps must be cut out of the tubing and replaced.

If you check the crimps with a micrometer or caliper, use the dimensions shown below.

Crimp Diameter Dimensions

Crimp outside diameters should fall within these dimensions when measured with a micrometer or caliper.

Ring Size	Minimum	Maximum
3/8"	0.580"	0.595"
1/2"	0.700"	0.715"
3/4"	0.945"	0.960"
1"	1.175"	1.190"

Daily Tool Calibration Check

Check tool calibration at least twice daily. Vanguard recommends at least the first and last crimp of the day. Accurately adjusted crimping tools are critical to the success of this fitting system. If the crimped rings do not gauge properly, the tool needs adjustment. The method for checking the crimping tool for proper calibration is:

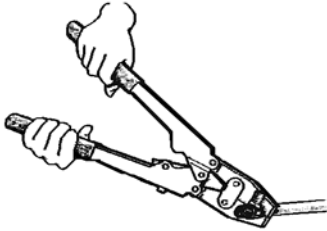

1. Assemble and crimp a fitting (*see page 7*).



2. Slide the correct size "GO" side of the crimp gauge over the crimp ring at least FOUR places. **DO NOT** gauge the crimp at the jaw overlap area.

3. **If the "GO" side of the gauge fails to slide over the ring**, the crimp tool requires calibration (ring is under crimped).

REMEMBER: A crimp tool which has worn parts may not calibrate. Return worn tools for repair or replacement.

4. If the "GO" side slides over the crimp ring, attempt to slide the correct size "NO GO" side of the gauge over the crimp ring in at least **four** places. **DO NOT** gauge the crimp at the jaw overlap area.

5. **If the "NO GO" side of the gauge slides over the crimp ring**, the crimp tool requires calibration (ring is over-crimped).

REMEMBER: A crimp tool which requires frequent calibration may require repair or replacement.

Adjusting “HAR” Tools

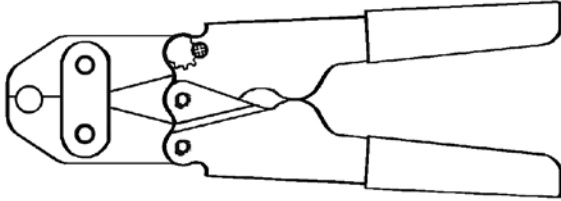

HAR TOOL

An accurately adjusted crimping tool is critical to the success of this fitting system. If the crimped rings do not gauge properly, the tool needs adjustment.

The method for adjusting the HAR tool is:

1. Open the tool handles.

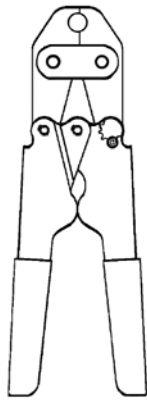

2. Note the position of the notched head of the adjustment cam in relation to the Phillips-head retaining screw.

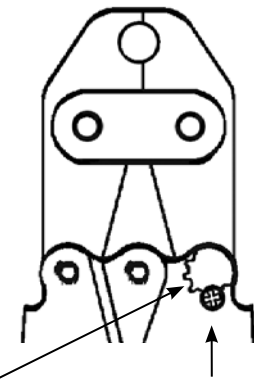

Adjustment Cam

Retaining Screw

3. Carefully remove the retaining screw and rotate the cam counterclockwise slightly until the retaining screw can be installed in the other threaded hole. This provides about 1/2 notch of adjustment.

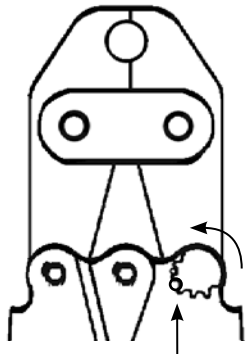

Reinstall Retaining Screw

4. Test the tool by crimping a joint and checking the crimped ring with the “GO” gauge. If the “GO” gauge slides over the ring then no further adjustment is needed. If the “GO” gauge will not slide over the crimped ring, then repeat the adjustment by rotating the adjustment screw counterclockwise an additional 1/2 notch and reinstalling the retaining screw in the other threaded hole.

A tool adjusted to the middle of the crimp diameter range may reduce the frequency of calibrations.

Lubricate lever points and pins on a regular basis, for optimal performance.

Product may not be exactly as illustrated.

Adjusting The “HCM” Tools

The HCM compact crimp tools are generally not capable of over-crimping (the “NO GO” gauge fits over the crimped ring). However, normal wear may cause the crimp size to increase to above the maximum allowed (the “GO” gauge does NOT fit). Tools have an adjustment feature built in and are easily identified by a hex head on the back-pin, see Figure 1. These tools may be adjusted to decrease the crimp diameter up to five times.

When an HCM crimp tool requires adjustment to a smaller crimp dimension, note the number to which the line on the hex head of the back pin points. (See Figure 1)

Carefully remove the retaining clip by inserting a small flat blade screwdriver in the loop of the clip and turning the screwdriver.

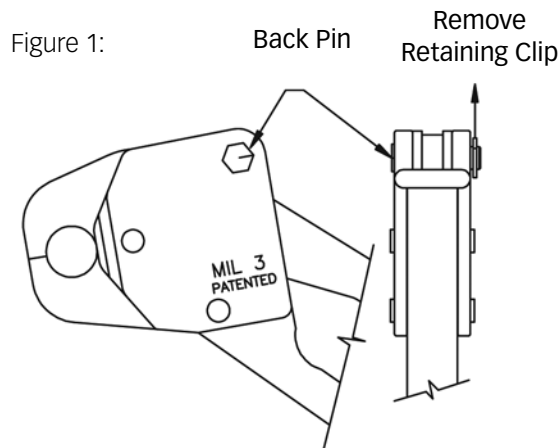

CAUTION!

The retaining clip is made from spring steel and may fly off of the pin if not removed carefully, possibly causing eye damage and loss of the clip.

From the clip end of the back pin, push it towards the tool body until the hex head on the other end of the pin just clears the body.

Rotate the pin until the line on the hex head points to the next higher number on the frame. Push the pin back into the frame and replace the retaining clip.

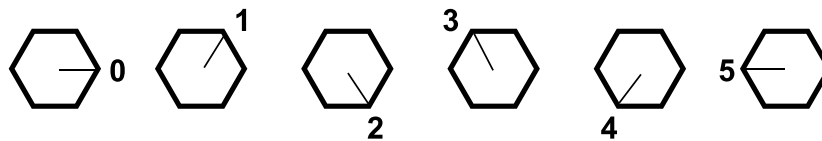

To reduce crimp size, rotate Back Pin to next higher number

Crimp a test joint and check the crimped ring for proper sizing with a GO/NO GO gauge or by measurement. Severely worn tools may require further adjustment. As the tool continues to wear with use, simply repeat these instructions as required.

System Sizing & Calculations

CANPEX systems should be designed following standard plumbing engineering practice. Follow local codes to determine minimum tubing size and required fixture pressures.

Pressure drop through fittings can be estimated from the chart below. Values are expressed in equivalent length of PEX, so add the values for the relevant fittings to the length of tubing in the run, and then determine the total pressure drop from the charts on the following page.

To determine the pressure drop through runs of CANPEX Tubing, refer to the pressure drop chart on the following page. For a known flow rate, tubing size and tubing length, the pressure drop through the run can be easily determined.

CANPEX and Pex Crimp Fittings Friction Loss - Equivalent Feet of SDR9 PEX Tubing

Size	Coupling	Elbow	Tee Run	Tee Branch
3/8"	2.9	9.2	2.9	9.4
1/2"	2.0	9.4	2.2	10.4
3/4"	0.6	9.4	1.9	8.9
1"	1.3	10.0	2.3	11.0
1-1/4"	5.5	11.0	4.8	13.0
1-1/2"	6.1	13.0	5.0	16.0

CANPEX PolyAlloy PEX Crimp Fittings Friction Loss - Equivalent Feet of SDR9 PEX Tubing

Size	Coupling	Elbow	Tee Run	Tee Branch
1/2"	7.1	16.5	7.2	17.9
3/4"	4.8	17.4	6.6	17.7
1"	4.5	18.0	6.0	17.0

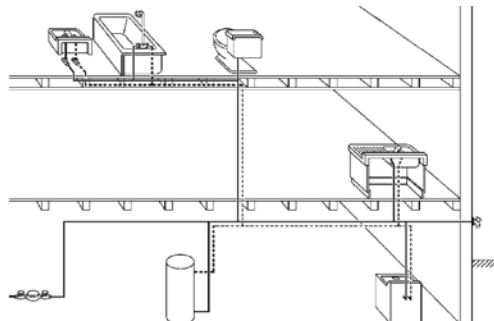

System Sizing & Calculations

Pressure Drop (psi per foot of PEX tubing)

GPM	3/8"	1/2"	3/4"	1"	1-1/4"	1-1/2"
1	0.070	0.016				
1.5	0.149	0.034				
2.2	0.303	0.069				
2.5	0.385	0.087				
3	0.539	0.122	0.023			
3.5	0.717	0.162	0.030			
4		0.208	0.039			
5		0.314	0.059			
6		0.440	0.082	0.024		
7		0.586	0.109	0.032		
8			0.140	0.041		
9			0.174	0.051		
10			0.211	0.062	0.024	
11			0.252	0.074	0.028	
12			0.296	0.087	0.033	
13			0.343	0.101	0.038	
14				0.116	0.044	
16				0.148	0.056	0.025
18				0.184	0.070	0.031
20				0.224	0.085	0.038
22				0.267	0.102	0.045
24					0.119	0.053
26					0.138	0.062
28					0.159	0.071
30					0.180	0.080
32					0.203	0.091
34						0.101
36						0.113
38						0.125
40						0.137

 = 8 fps per size tubing

NOTE: Maximum flow for each size based on 12 FPS velocity. PSI x 2.307 = head loss.

Installing CANPEX™ Tubing

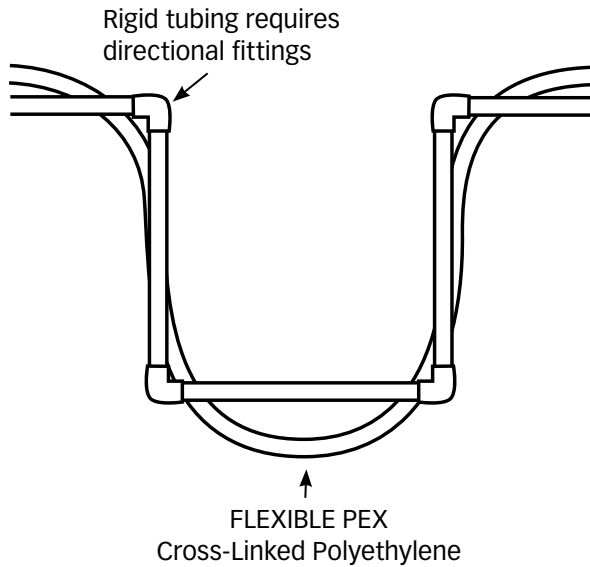

CANPEX tubing is flexible, reducing the need for most directional fittings

Care should be exercised when pulling PEX tubing to prevent cutting or abrading. Care also must be taken to prevent kinking of the coiled tubing. If kinking should occur, these sections must be cut out and a coupling installed.



CAUTION!

DO NOT BEND 1/2" TUBING 90° WITHIN A 3 1/2" STUD WIDTH when stubbing out. Use an elbow or stub-out elbow.

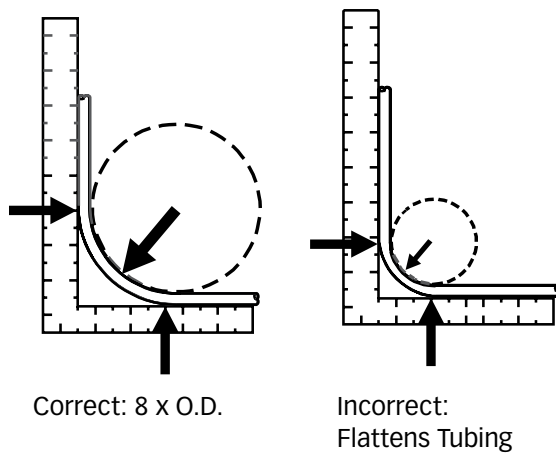

DO NOT bend CANPEX in a radius smaller than eight (8) times the outside diameter of the tubing. Flattened tubing is damaged and must be cut out and replaced.

If bending against the coil direction when using coiled tubing, the bending radius is twenty four (24) times the outside diameter of the tubing.

Refer to these dimensions for proper radius bends:

Tubing Size	Natural Radius	Radius against coil
3/8"	4"	12"
1/2"	5"	15"
3/4"	7"	21"
1"	9"	27"

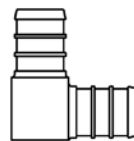

For bends smaller than 8 x outside tube diameter, install an elbow fitting

Installing CANPEX™ Tubing

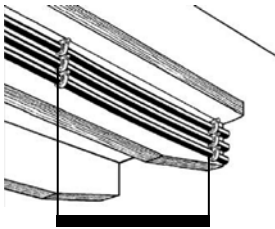
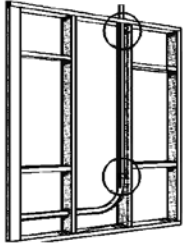

Support horizontal tubing at least every 32" (or every 48" in a Manufactured Home or Recreational Vehicle).

Vanguard CANPEX is flexible and requires fewer fittings than conventional piping material. Because of this flexibility, proper and adequate use of clamps, straps or hangers is required for installation.

SUSPENDED TUBES AND BUNDLES should be supported at least every 32" horizontally, at each floor level vertically and at significant changes of direction with clamps, hangers or plastic strapping. Tubes running through holes drilled in joists or studs or laying on top of rafters do not require further support unless the joist or stud spacing exceeds 32".

Supports may be the same as those commonly used for CANPEX or other piping systems, keeping in mind size and weight of the tubing when filled with water.

ALWAYS allow some slack. Typically 7" per 50' in the tubing will accommodate contraction when cold temperatures are encountered.

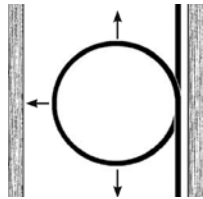

CANPEX expands or contracts 1" in every 100' of pipe for every 10°F of temperature change. You should allow for this expansion and contraction in your installation procedures. **ALWAYS** cut the pipe too long.

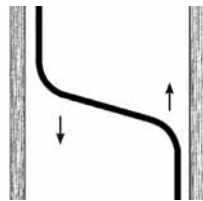

In the normal process of installing tubing, slack is generally provided by snaking the tubing around obstacles and by some sagging between supports. A change in direction offset or loop can be used when slack requirements are not met by these other installation methods.

OFFSETS AND LOOPS are not required in CANPEX lines which have sufficient slack to provide for expansion and contraction. Strapping support should be firm but loose enough to allow the pipe to move as it expands and contracts.

Since plumbing fixtures are generally located in groups, and there may be several distribution lines running to approximately the same location, it is easiest to run these distribution lines bundled together. Hot and cold lines may be run in the same bundle, for neat appearance, bundles can be tied with nylon ties or plastic strapping at regular intervals.

HOLES DRILLED through studs, joists, plates, headers, etc. must be large enough to accommodate tubing bundles without binding, to allow free movement. Several smaller holes (accommodating a few lines each) may be preferable to drilling a bundle-size hole. In no case should the hole size exceed building code guidelines, as this could weaken the structural support members.

Installing CANPEX™ Tubing

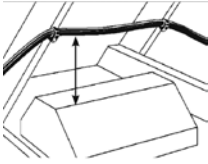

12" vertical clearance

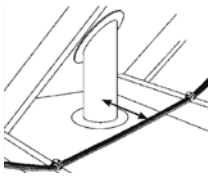

6" horizontal clearance

Keep the CANPEX tubing a minimum of **12" vertically and 6" horizontally** from sources of high heat such as recessed light fixtures, gas flue vents, heating appliances, or electric motors. Forced air heating ducts are not generally considered sources of high heat. These areas of installation should be rechecked after further construction and other mechanical systems have been installed. PEX can be run in return air plenums.

REMEMBER: It is the responsibility of the installer to ensure that further construction, finishing and other mechanical system installations do not compromise the integrity and service life of the CANPEX tubing.

Installation Temperature Range

The flexibility of CANPEX tubing and the strength of the CANPEX connections combine to provide a system that can be installed during any weather. The positive compression provided by the CANPEX hand tools allow installation in temperatures down to -30°C.

Freezing

The flexibility of CANPEX tubing makes it resistant to damage from freezing, but precautions to prevent freezing should be taken when low temperatures might be encountered.

Insulating each CANPEX tube individually or as a group is not generally necessary if the CANPEX tubing is installed within the insulation envelope of the structure, i.e. the heated area. For example, the tubing may be installed under the insulation in the attic or within an interior wall of a heated space.



PEX tubing systems should not be intentionally subjected to freezing. Do not use open torch or excessive heat to thaw PEX tubing. Tubing failure or damage can result. Heat must be applied directly to the frozen tubing section. Temperature on tubing shall not exceed 180°F.

Several suitable methods exist to thaw PEX tubing. They include:

- Hot water
- Wet hot towels
- Hand-held hair dryer
- Low wattage electrical heating tape.
- A commercial system which pumps heated water through a tube to the ice blockage, and returns the cooled water for reheating.

Installing CANPEX™ Tubing

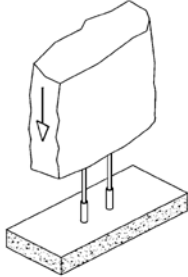

Protect the CANPEX tubing with non-metallic sleeving material where it **enters and/or exits a concrete slab**. CANPEX need not be sleeved its entire length within the slab. However, full length sleeving is allowed.

Penetrations **through concrete walls** may be sleeved with a larger, rigid sleeve. Protect CANPEX from any sharp edges where it enters and exits larger sleeving material. (See detailed guidelines on page 23.)

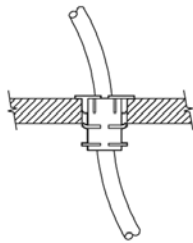

Tubing penetrations **through structural members** may require sleeving or the installation of an insulator. When the tubing penetrates at an angle in relation to the hole, it may be subject to a sharp edge which could damage the pipe. Acceptable sleeving materials include flexible plastic tubing, foam-cell pipe insulation or an approved plastic insulator. It is not generally necessary to sleeve CANPEX when penetrating wooden framing members or non-metallic finished or unfinished walls. If there is a doubt, sleeve the pipe or install an insulator.

SLEEVE all penetrations of metal, metal studs and masonry or concrete.

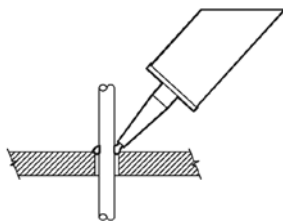

When penetrations must be sealed for **AIR INFILTRATION** purposes, there are several options available. A good grade of silicone, acrylic or siliconized acrylic caulking (DO NOT use oil-base caulks), most of the canned expanding foams, and open- or closed-cell pipe insulation are good sealing materials and may be used in direct contact with CANPEX tubing. Other materials may be used provided they do not cause short or long-term damage to the CANPEX PEX. If there is no information available on the compatibility of the proposed sealing materials, wrap the tubing with several layers of aluminum foil in the area of contact and extending a few inches on both sides before applying any sealing material.

FIRE STOP - Most building codes require the use of a fire-stopping compound when tubing penetrates a fire-rated wall. There are a number of fire stopping compounds readily available that have been listed for use with PEX tubing. These compounds come in standard caulking tubes and are identified as water-based, acrylic or latex. Consult the compound manufacturers' instructions for proper application.

Installing CANPEX™ Tubing

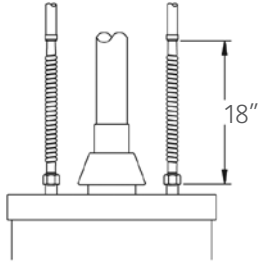

Use metallic connectors to attach CANPEX to **GAS WATER HEATERS**. Install a minimum 18" of metallic or other piping between the water heater and CANPEX.

For **ELECTRIC WATER HEATERS**, CANPEX may be connected with standard metallic termination fittings (such as swivel elbows and straight swivels) to the water heater inlet and outlet nipples. CANPEX may be used to connect to **INSTANTANEOUS WATER HEATERS** or other hot water producing devices. However, consult manufacturers recommendations for use with plastic tubing and ensure temperature and pressure do not exceed the maximum ratings of the CANPEX tubing. CANPEX can be used for water heater **PRESSURE/TEMPERATURE RELIEF LINES**.

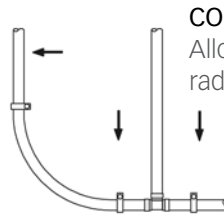

CORRECT:
Allows a proper radius bend

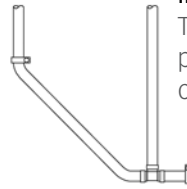

INCORRECT:
Tubing shall not be pulled tight to make connection

Do NOT pull tubing tight at connections. Prevent unnecessary strain on the tubing, fittings and connections with straps or clamps.

When completing fixture connections, cut the lines carefully and leave sufficient tubing to make the connection without putting undue stress on the tubing, fitting or connection.

Do NOT pull tubing tight at connections. Prevent unnecessary strain on the tubing, fittings and connections with straps or clamps.

NOTE: When connecting with a compression type fitting, make certain the tubing is fully inserted into the connection and the nut is properly tightened.

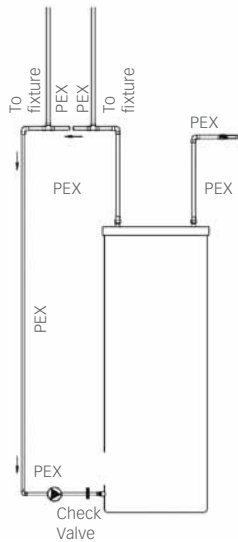

Continuously Recirculating Hot Water Plumbing Loops

CANPEX can be used in continuously recirculating domestic hot water plumbing loops, provided:

1. The plumbing loops shall operate with water temperatures of 140°F or lower, as required by most model plumbing codes.
2. The recirculation loop is for supplying hot water more quickly to the fixture.
3. The tubing is marked as rated for “continuous recirculation” as evidenced by the NSF third party certification marking PEX 5306. (See the example marking below.)

www.vpfl.ca CANPEX PEX POTABLE TUBING NSF-pw PEX 5306

Noise And Water Hammer In Pex Systems

As with all plumbing materials under some operating conditions, water hammer can occur in PEX plumbing systems. The inherent flexibility of CANPEX drastically reduces the magnitude of pressure surges compared with metallic plumbing materials. Damage to plumbing components in a PEX system due to these pressure surges is highly unlikely, although noise can sometimes result. Fortunately, there are solutions to minimize or eliminate water hammer noise.

- Install fixtures that are not water hammer prone. As a general rule, two-handle fixtures are less likely to cause hammer than single-handle fixtures. Single-handle shower valves, which rotate to close and therefore are difficult to close quickly, might be good choices.
- Clamping or strapping more frequently may help prevent tubing noise. It is very important that the tubing not be in contact with wallboard, forced air ducts or other high resonance articles. Insufficiently or improperly clamped or strapped tubing may move during fixture operation and hit against these surfaces.
- Install a water hammer arrester at fixtures where noise is a problem. A water hammer arrester installed as close as possible to the fixture on the cold water side only will eliminate the source of the noise; the pressure wave. It should be noted that even with an arrester, tubing which is clamped or strapped insufficiently may still hit against something as it moves slightly when the water flow is stopped.
- Avoid operating fixtures in such a way that causes near instantaneous shut off. Simply closing fixtures in a less abrupt manner can eliminate hammer noise.

Transitioning to Fixtures

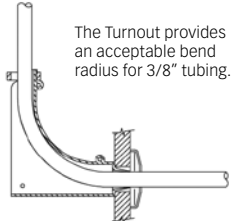

The Turnout provides an acceptable bend radius for 3/8" tubing.

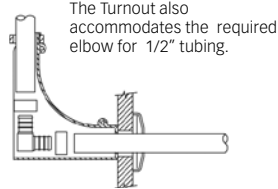

The Turnout also accommodates the required elbow for 1/2" tubing.

The connection of CANPEX distribution lines to individual fixtures may be accomplished with a variety of fittings available from Vanguard. CANPEX may be stubbed directly out of the wall with the use of a Turnout. At floor levels above a crawl space, basement, or on upper floors, it may be desirable to run the tubing through the floor directly to the fixture, rather than behind the wall.

Care must be taken to avoid imparting severe bending stresses to the tubing when exiting a wall or floor. At basement or slab levels the bend radius restrictions may force you to exit the wall at an angle or to install an elbow or stubout elbow in traditional fashion.

Threaded Fittings

Brass or copper threaded fittings should be used to connect with other metallic-threaded fittings. Plastic fittings SHOULD NOT be used because of likely cross-threading, expansion and contraction differences, and varying tolerances of metallic female threads — all resulting in potential leaks. Use Teflon™ tape to lubricate or seal all **metallic** threaded fittings. **Insert connections do not require a lubricant** and none shall be used.

Typical Vanguard PEX/pipe thread adapter fittings include:

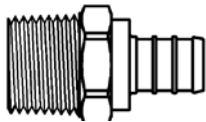

- 3/8" Insert x 1/2" MPT
- 1/2" Insert x 1/2" MPT
- 1/2" Insert x 3/4" MPT
- 3/4" Insert x 1/2" MPT
- 3/4" Insert x 3/4" MPT
- 3/4" Insert x 1" MPT
- 1" Insert x 3/4" MPT
- 1" Insert x 1" MPT

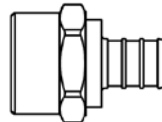

- 3/8" Insert x 1/2" FPT
- 1/2" Insert x 1/2" FPT
- 1/2" Insert x 3/4" FPT
- 3/4" Insert x 3/4" FPT
- 3/4" Insert x 1/2" FPT
- 3/4" Insert x 1" FPT
- 1" Insert x 1" FPT

- **SWEAT COPPER or BRASS FITTINGS:** Always solder sweat adapter fittings into place and allow to cool **before** attaching CANPEX tubing. Heat damage to CANPEX may result if it is attached during the heating process.



NOTE: Never expose CANPEX to direct flame or high temperatures. Proper installation procedures can help ensure the long life of the CANPEX plumbing system. Braze, solder or weld any metallic fittings and allow to cool **BEFORE** you connect them to CANPEX.

Transitioning to Fixtures

Water Closet Connections

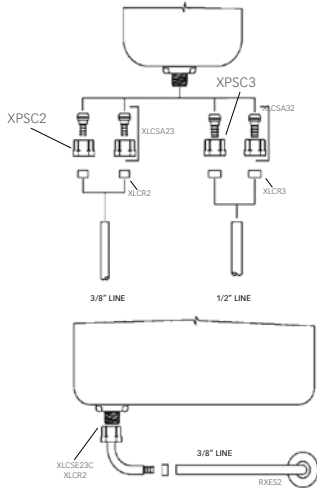

Riser Connections

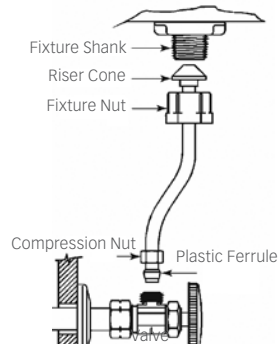

Slide compression nut and supplied plastic ferrule over tube as shown. The long taper of the ferrule goes towards valve. Thread fixture nut onto valve. Tighten fixture nut hand tight plus an additional 1/2 turn.

Tighten compression nut according to valve manufacturer's recommendations.

Faucet Connections - Lav Or Kitchen

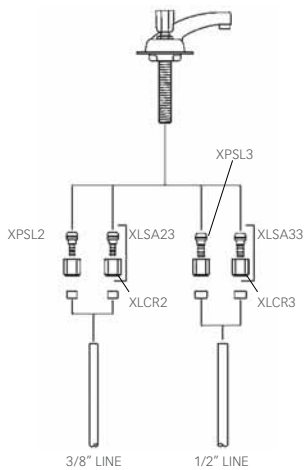

Ice Maker Hook-Up

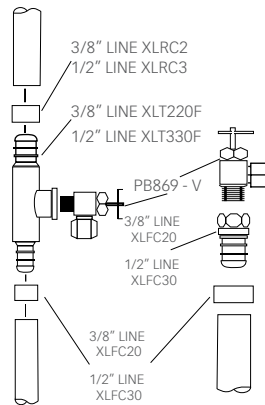

Install from the cold side of the kitchen faucet or other convenient supply.

Hose Bibb Connections

Hose bibbs supported by the structure can be connected directly.

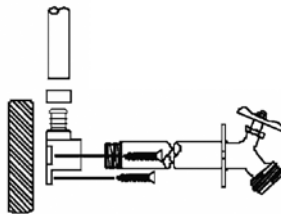
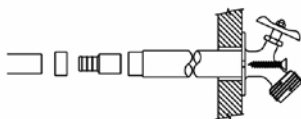

Free Standing Hose Bibbs shall not be supported by CANPEX. Well anchored drop ear fittings or metal pipe shall be used to install hose bibbs.

Proper Use of Materials

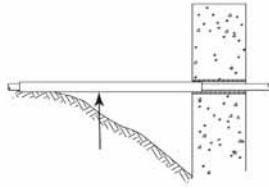

Sleeve to undisturbed earth with rigid pipe.

Penetrating a Foundation Wall

To prevent shearing or pinching-off of the tube when backfill below the tubing settles, plastic tubing must be properly sleeved. If there is an area of over-excavation through which the tubing must pass, it shall be sleeved with a larger rigid pipe (schedule 40 PVC or equivalent) to undisturbed earth. The foundation end of the rigid pipe must also be supported by the foundation wall. Slight over-excavations (12" or less) do not require rigid sleeving when the area below the tubing is backfilled and well compacted to the level of penetration. Always sleeve plastic tubing where it passes through concrete.

A larger, rigid sleeve must be used for foundation penetrations or CANPEX can be installed through a drilled hole with other appropriate sleeving materials. The space between PEX and the sleeve or hole can be sealed with silicone, acrylic, or siliconized-acrylic caulking. Do not cast CANPEX directly through the foundation using thin, conforming sleeving materials. Normal ground movement can cause severe tubing damage where the tubing penetrates the foundation if these guidelines are not followed.

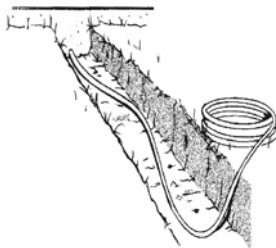

Snake tubing from side to side to allow for tube contraction.

Ground and Under-Slab Installation

When installing CANPEX in the ground and/or under-slab, the tubing should be snaked from side to side in the prepared trench. The trench bottom must be smooth and free of rocks and debris. Lay the tube directly on the trench bottom. Tubing must be continuously supported by the trench bottom.

Bed and haunch the tube with small, loose, easily compacted backfill material. Compact this material to at least 6" above the tube before final backfilling with any larger or coarser materials. For further information on proper backfill, consult ASTM D2774.

Use only continuous lengths of tubing (no fittings) in or under a concrete slab. Any connections shall be outside the slab or in an access box.

Vanguard crimp insert fittings connections may be direct buried but not under a concrete slab. These fittings, including crimp rings, shall be wrapped securely with self fusing silicone rubber tape (minimum .020 thickness).

When direct burial of metallic water service fittings are used to connect water service tubing coming into the house, those fittings should be made from ASTM B62 UNS C83600 cast bronze (per AWWA standards) or B140 UNS C31400 "DZR" brass (check with fittings manufacturer). In those areas with aggressive soil, such as desert areas, wrapping as referenced above is recommended.



CAUTION!

CANPEX tubing shall not be installed underground in areas of known chemical contamination of the soil, such as organic solvents or petroleum distillates, or where there is a high risk of chemical spills.

1. Upon completion of the installation, the system should be filled and hydrostatically tested. Use only POTABLE water for testing.



WATER TESTING SHALL BE AVOIDED DURING FREEZING CONDITIONS.

(See options 3 and 4 below.)

2. Hydrostatic testing of the CANPEX plumbing system is to be conducted according to local code requirements. Test pressure shall be not less than 100 psi nor greater than 225 psi.

NOTE: Some plumbing fixtures may not withstand test pressures greater than 80 Consult fixture manufacturers' instructions for pressure limitations or plug all distribution lines at the fixture end. The system shall, at a minimum, withstand the test pressure, without leaking, for a period of 15 minutes.



WARNING! PRESSURES USED IN TESTING CAN BLOW UNMADE OR INCOMPLETE CONNECTIONS APART WITH TREMENDOUS FORCE!

This force is many times greater when air is used for a test media. To reduce the risk of personal injury, ensure that all connections are completed before testing. Use only the pressure and time required to determine that the system is leak free.

3. Fluid testing the CANPEX system at temperatures below freezing (less than 32°F, 0°C) may be performed using a solution of water and NON-TOXIC antifreeze such as propylene glycol (typically called RV antifreeze). If such a solution is used, the antifreeze solutions must be sufficiently concentrated to withstand the lowest temperature encountered while the testing fluid is in the system. Antifreeze solutions should be purged and the system flushed with potable water prior to consumer use.



THE WATER HEATER SHALL BE ISOLATED AND NOT INCLUDED IN THE SYSTEM AIR TEST.

Pressure Testing in Cold Conditions

Air pressure testing of a CANPEX plumbing system is acceptable and preferred to hydrostatic testing in areas where cold weather could freeze the system or where water is not available. Vanguard recommends that the installer pressurize the system with compressed air or another acceptable test medium, such as dry nitrogen, after installing and capping distribution lines. Air testing shall utilize a pressure of not less than 40 psi and not greater than 100 psi. The system shall be tested for a minimum of 15 minutes. During the test, system pressure shall drop no more than 8 psi in the one hour period.

If the pressure in the system declines more than 8 psi during the minimum 15 minute period, re pressurize the system to the original test pressure, and retest.* If the system pressure declines more than 8 psi again during the test period, test the distribution line test plugs or any other fittings in the system with the approved leak detection solution. (Any connection found to be in question must be replaced or remade and the pressure test repeated.)

System Testing

If it's determined that the connections are leak free, then the tubing must be inspected for damage. Damaged sections must be cut out and repaired with a coupler or if feasible, the tubing section replaced.

For leak detection, use only a mixture of Original Palmolive Green™ dishwashing soap (#46100-46200) or Palmolive Ultra™ (#356140 or 46128) mixed with potable water at a ratio of 2 ounces of soap to one gallon of water (mix Ultra at a ratio of 1.5 ounces per gallon.)

* During the initial test pressurization period, the system pressure indicated on the gauge pressure drop is dependent on ambient temperature, system capacity, and test pressure but shall not be more than 8 psi in an hour.



Test shall be conducted when significant changes to temperature AREN'T expected.
Please note significant changes in ambient temperature also can affect system pressure.



WATER (NOT ANTIFREEZE SOLUTION) MUST BE PURGED OR DRAINED FROM THE SYSTEM IF TEMPERATURES ARE EXPECTED TO FALL BELOW FREEZING (32°F, 0°C). Low pressure compressed air can be used for purging.



FOLLOW ANTIFREEZE MANUFACTURERS INSTRUCTIONS FOR CONCENTRATIONS. USE ONLY NON-TOXIC ANTIFREEZE APPROVED FOR USE IN DRINKING WATER SYSTEMS.

Local codes may require system disinfection. When no other method is available, follow the time limitations and exposure levels shown below:

1. Use a chlorine solution and one of the exposure durations listed below:

CONCENTRATION	PERIOD	AUTHORITY
200 PPM	3 HOURS	AWWA
50 PPM	24 HOURS	AWWA

2. Mix the disinfection solution thoroughly before adding it to the system.
3. The chlorine solution must reach all parts of the system. Open all fixtures (both sides) and flow water until a chlorine smell is present. As an alternative, chlorine test tablets can be used to detect chlorine at each fixture.
4. The chlorine source for the solution can be, but is not limited to, the following:

CHLORINE SOURCE	%ACTIVE CHLORINE	FORM	AMOUNT PER 100 GAL WATER FOR A 100 PPM SOLUTION
Laundry Bleach	5.25	Liquid	1 1/2 pints (24 oz.)

5. After the solution has been in the system for the time required by the Authority Having Jurisdiction or the exposure durations listed in step 1 above, the system shall be flushed completely with potable water.
6. The system must be purged or drained of all water or protected from freezin

FAILURE TO FLUSH THE SYSTEM NOTICE!

To prevent reduced service life of system components, disinfection solutions shall not be allowed to stand in the system longer than 24 hours. Thoroughly flush the system with potable water after disinfection.

CANPEX™ Warranty

VANGUARD LIMITED WARRANTY

CANPEX™, CANPEX™ Ultra and CANPEX™ Oxygen Barrier PEX Tubing

Subject to the conditions in this Limited Warranty, VANGUARD PIPE & FITTINGS LTD. (VPFL) warrants to licensed plumbers who purchase and properly install in a hot and cold potable water distribution systems its CANPEX, CANPEX Ultra cross linked polyethylene pipe and tubing (PEX) with F1807 crimp insert fittings, or CANPEX Oxygen Barrier PEX in a certified design radiant heating system, meeting the specifications of CSA B137.5 and ASTM F876/877 as certified by a recognized third party, that the pipe or tubing and insert fittings (ASTM F1807) under normal conditions of use, will be free from failure caused by manufacturing defects for a period of twenty five (25) years from date of installation.

Under this warranty, you only have a right to reimbursement if the failure or leak resulted from a manufacturing defect in the products covered by this warranty and occurred during the warranty period. You do not have a remedy or right of reimbursement under this warranty and this warranty does not apply if the failure or any resulting damage is caused by: (1) components in the plumbing systems other than those manufactured by VPFL; (2) not designing, installing, inspecting or testing the systems in accordance with VPFL installation instructions at the time of the installation, applicable code requirements or provided guidelines such as the Radiant Panel Association, and good plumbing practices; (3) improper design of the system; (4) exposure to unauthorized antifreeze, rust inhibitor or other treatment fluids or concrete additives or by failure to provide recommended water temperature levels or other misuse or abuse of the tubing; (5) damage caused to the product prior to, during, or after installation, inadequate freeze protection, exposure to water pressures or temperatures in excess of the limitations on the pipe or tubing, or exposure to unauthorized solvents or chemicals; and (6) natural disasters such as fire, flood, wind, ground movement, or lightning.

In the event of a leak or other failure in the system, it is the responsibility of the property owner to contract and pay for the repairs. Only if the warranty applies will VPFL be responsible for reimbursement under this warranty. The part or parts that you claim failed should be kept and VPFL contacted in writing to the address below within thirty days (30) after the leak or failure and identifying yourself as having a warranty claim. You should be prepared to ship, at your expense the product which you claim failed due to a manufacturing defect, document the date of installation, and the amount of any claimed bills which you wish to be reimbursed. Within a reasonable time after notification, VPFL will investigate the reasons for the failure, which includes the right to inspect the product at VPFL and reasonable access to the site of the damage in order to determine if the warranty applies. VPFL will notify you in writing of the results of its review.

In the event that VPFL determines that the failure or leak and any resulting damages were the result of a manufacturing defect in the products covered by this warranty, VPFL will reimburse the property owner for reasonable repair or replacement charges to include drywall and painting or plastering costs, as well as damages to personal property resulting from the failure or leak. **VPFL shall not be liable for consequential economic loss damages under any legal theory and whether asserted by direct action, for contribution or indemnity or otherwise.**

The above limited warranty is in lieu of all other warranties express or implied, including but not limited to, the implied warranties of the merchantability and fitness for a particular purpose. Other than this limited warranty, VPFL does not authorize any person or firm to create for it any other obligation or liability in connection with any warranty extended by them to builders or owners of site built construction.



Vanguard Pipe & Fittings Ltd.

8125 North Fraser Way
Burnaby, BC V5J 5M8
Canada

F. 604.431.5029

T. 604.431.5024

TF. 888.PIPEPEX (747.3739)

vanguard.ca